

OSMO MOBILE

User Manual

V1.0 2016.09

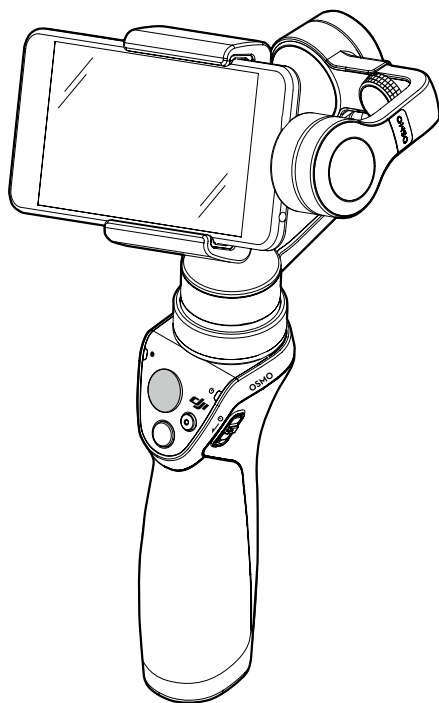

Searching for Keywords

Search for keywords such as “battery” and “install” to find a topic. If you are using Adobe Acrobat Reader to read this document, press Ctrl+F on Windows or Command+F on Mac to begin a search.

Navigating to a Topic

View a complete list of topics in the table of contents. Click on a topic to navigate to that section.

Printing this Document

This document supports high resolution printing.

Using this Manual

Legend

 Important

 Tips

Install the DJI GO App

Search for 'DJI GO' on the App Store or Google Play and install the app on your mobile device.



 DJI GO supports iOS 8.0 (or later) or Android 4.4 (or later).

Contents

Using this Manual	2
Legend	2
Install the DJI GO App	2
Introduction	4
Getting Started	5
Intelligent Battery	5
Mount and Balance the Mobile Phone	7
Optional Accessories	8
Using the Osmo Mobile	9
Controls and Operations	9
Operation Modes	12
DJI GO App	14
Download	14
Connecting to the DJI GO App	14
Key Pages	15
Upgrading the Firmware	18
How to Upgrade	18
Specifications	18

Introduction

The OSMO™ Mobile is an advanced 3-axis gimbal that stabilizes and controls your smartphone, turning it into a smart motion camera. Its light and ergonomic design places physical controls at your fingertips, to form a powerful go anywhere smartphone filmmaking device. The DJI GO app brings ActiveTrack and Motion Timelapse features to the Osmo Mobile.

Equipped with 3-axis stabilization and SmoothTrack technology, the Osmo Mobile compensates for natural arm movements and smooths out transitions, creating seamlessly smooth video. Finer operations can be done with the joystick, and the phone can be instantly positioned by hand. The DJI Rosette Mount on the side of the handle supports a number of accessories, including an Extension Rod, a Tripod, and various mounts for specialized filmmaking applications.

At a Glance:

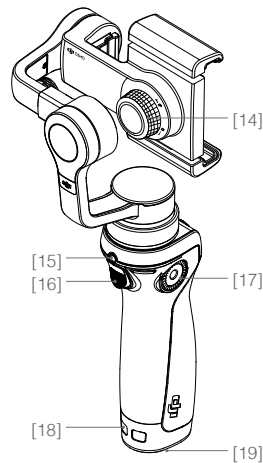
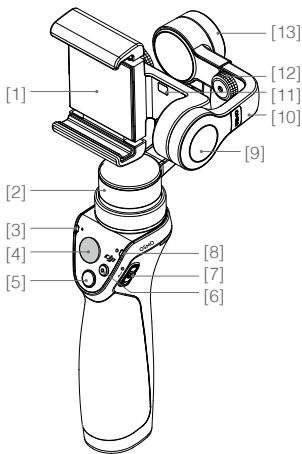

- [1] Mobile Phone Holder
- [2] Pan Motor
- [3] Camera Status LED
- [4] Joystick
- [5] Shutter Button
- [6] Record Button
- [7] Power Switch
- [8] System Status LED
- [9] Tilt Motor
- [10] Adjustable Arm

- [11] Mobile Phone Detection Sensor
- [12] Balance Adjustment Knob
- [13] Roll Motor
- [14] Holder Lock Knob
- [15] Charging/Upgrade Port
- [16] Trigger
- [17] DJI Rosette Mount
- [18] Lanyard Hole
- [19] Battery Cover

Getting Started

Intelligent Battery

The 980 mAh Intelligent Battery can power the Osmo Mobile for about 4.5 hours.

Intelligent Battery Functions

Battery Balancing	Balances the voltage of each cell during charging.
Overcurrent Protection	Stops charging if the charging current is too large.
Overcharge Protection	Stops charging if its voltage is too high.
Over-discharge Protection	Stops discharging if its voltage is too low.
Short Circuit Protection	Cuts the power supply if a short circuit is detected.
Temperature Control	Stops charging if the core temperature falls below 41°F (5°C) or exceeds 104°F (40°C).
Battery Level Display	The battery level is displayed in the DJI GO app.

Battery Specifications

Model	HB01-522365
Type	LiPo
Capacity	980 mAh
Energy	10.8 Wh
Voltage	11.1 V
Charging Temperature	41° to 104° F (5° to 40° C)
Operating Temperature	32° to 104° F (0° to 40° C)



- Be sure to fully charge the Intelligent Battery for the first time to activate it.
- Read the user manual, Intelligent Battery Safety Guidelines before use. The user takes full responsibility for all operations and usage.

Inserting the Battery

Slide the locking switch at the base of the Osmo Mobile to open the battery cover. Insert the battery and lock the battery cover.

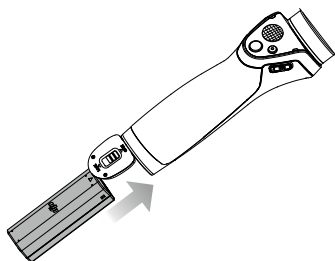

Charging

To charge the Osmo Mobile, connect the USB adapter (not included) to the charging port using the provided power cable.

The battery is fully charged when the system status LED become solid green.

USB Adapter Charging Time : 3 hours (when charging at 1 A)

Maximum Supported USB Charging Current: 2.1 A

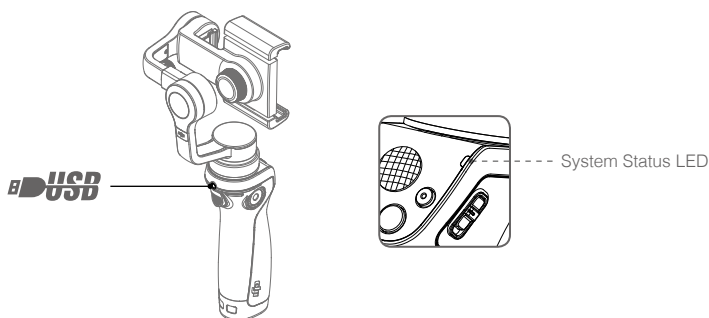

 Only use the Power Cable with the Osmo Mobile. Damage may occur if the Power Cable is attached to any other device's 3.5 mm port.

Removing the Battery

Slide the locking switch at the base of the Osmo Mobile to open the battery cover. Push the red safety hook away from the battery to let it pop up, and then remove the battery.

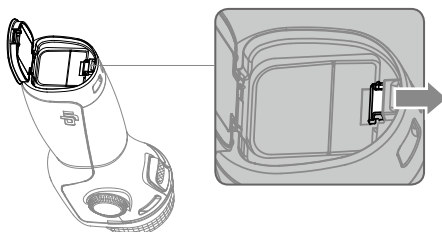

Mount and Balance the Mobile Phone

1. With the Osmo Mobile powered off, loosen the Holder Lock Knob, place the mobile phone in the mobile phone holder and tighten the knob to secure its position.

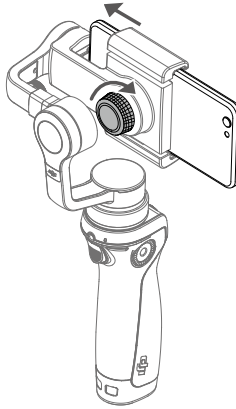

2. The system is balanced if the mobile phone remains level when released, balanced only by the gimbal.

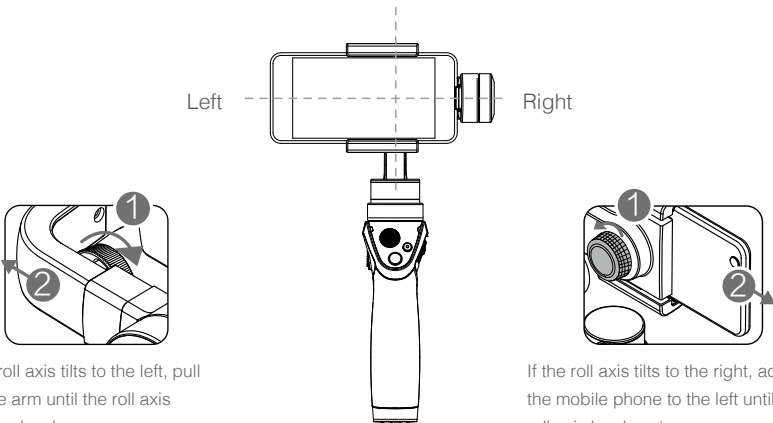

If the roll axis tilts to the left, pull out the arm until the roll axis remains level.

If the roll axis tilts to the right, adjust the mobile phone to the left until the roll axis levels out.

- ⚠ Do not power on the Osmo Mobile without a mobile phone. The Osmo Mobile will not work if no device is detected by the Mobile Phone Detection Sensor.
- It is important to balance the mobile phone in order to achieve optimal performance. The Osmo Mobile should only be balanced when powered off.

Optional Accessories

DJI provides various optional accessories for the Osmo Mobile.

Osmo Base

Provides a stable platform for your Osmo to stand upright.



Universal Mount

Used to mount external devices such as a flashlight.

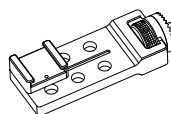

Extension Rod

Good for taking group selfies, overhead shots or reaching into small spaces.

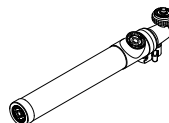

Tripod

For stationary shots that require steady footage. The tripod must be used with the Extension Rod.

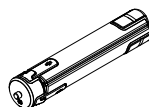

High Capacity Intelligent Battery

Battery capacity is 1225 mAh.

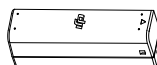

Osmo Charger

The Osmo Charger is designed to charge the Osmo series Intelligent Battery by connecting to a power outlet.

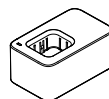

Osmo Quad Charging System

Used with the dedicated DJI Battery Chargers, which can charge up to four Osmo Intelligent Batteries.

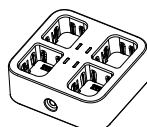

Using the Osmo Mobile

Controls and Operations

The gimbal anticipates handle movement to smooth out pan and tilt transitions, and uses SmoothTrack technology to reduce mobile phone shakes from natural arm movements. You can position the mobile phone directly by hand.



Additionally, there are buttons on the front and back of the handle that allow for finer control over the gimbal and mobile phone. All of the buttons and controls are described below.

[1] Power Switch

To turn on/off the Osmo Mobile, pull the power switch down and hold for 1.5 seconds. With the Osmo Mobile powered on, pull the power switch and then release quickly will cause the Osmo Mobile to go in or out of sleep mode.

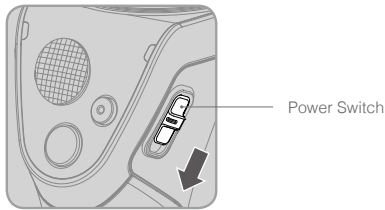

 Hold the Osmo Mobile steady and upright while it is starting up.

[2] Joystick

Vertical movement tilts the camera. Horizontal movement pans the camera. Joystick control direction can be set in the DJI GO app.

[3] Shutter Button

Press this button to take photos based on your settings in the DJI GO app. Hold down shutter button to capture continuous photo.

[4] Record Button

Press this button once to start recording video, and again to stop recording.

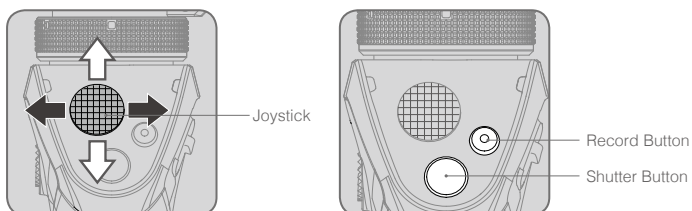

[5] Camera Status Indicator

Indicates the camera's system status. Refer to the table below for details.

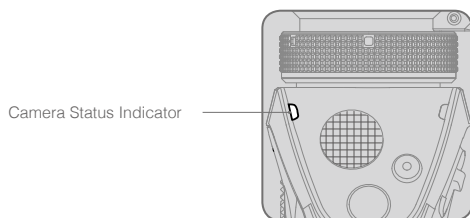







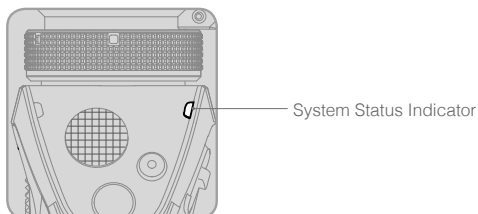



Blinking Pattern		Descriptions
○	LED Off	No device connected.
ⓘ —	Solid Blue	Camera is functioning normally.
ⓘ ·····	Blinks Green	Shooting photo.
ⓘ ·····	Blinks Green slowly	Self-timer
ⓘ · · · · ·	Blinks Green for each shot	Burst shooting
ⓘ ·····	Blinks Red slowly	Recording video

[6] System Status Indicator

Indicates the status of the Osmo Mobile. Refer to the table below for details.



Blinking Pattern	Descriptions
 — Solid Green	The Osmo Mobile is functioning normally or firmware upgrade successful.
 Blinks Green	The Osmo Mobile is initializing / Exiting sleep mode
 — Slow Pulsing Green	Standby
 — Solid Yellow	The trigger is being held down and the gimbal is in Lock Mode
 Blinks Yellow	The gimbal is not functioning normally.
 — Slow Pulsing Green/ Yellow/Red	Charging
 Blinks Red Slowly	Low battery level warning
 Blinks Red Quickly	Critical low battery level warning
 — Solid Red	Non-DJI battery detected or firmware upgrade failed.

 Tap twice on the trigger to re-center your phone. If the system status LED blinks yellow, it indicates an error in the gimbal.

[7] Trigger

Hold down the Trigger to enable Lock Mode. The gimbal will stay in its current position regardless of handle movement. The Osmo Mobile will return to SmoothTrack Mode once the Trigger is released.

Quickly tap the Trigger twice to center the mobile phone.

Tap three times on the trigger to switch between your phone's front and rear camera. Switching cameras during video recording will stop the recording.

Hold down the trigger and push the joystick up and down to zoom. This function is available in the DJI GO app metering mode and when using your phone's rear camera only. Currently available on iOS only.

[8] Charging/Upgrade Port

To charge the Osmo Mobile by connecting to this port.

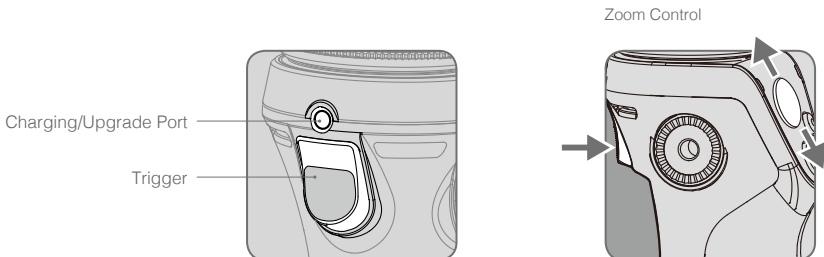

Operation Modes

Upright Mode

Upright Mode can be used without any user input. In this mode, quickly tap the trigger twice to center the mobile phone.

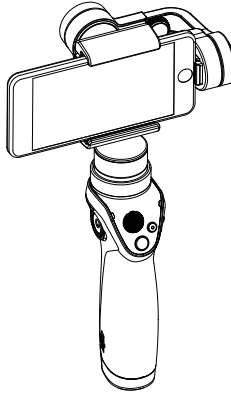

Underslung Mode

Holding the Osmo Mobile upside down will cause it to enter Underslung Mode, in which the mobile phone can easily capture images from a lower position.

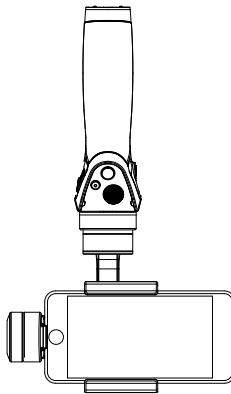

Flashlight Mode

Rotate the Osmo Mobile forward 90 degrees to go from Upright Mode to Flashlight Mode. In Flashlight Mode, pushing the joystick up and down will tilt the gimbal, pushing the joystick left and right will have no effect.

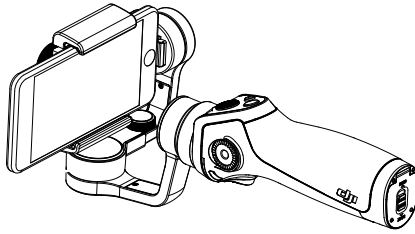

Portrait Mode

Rotate the Osmo Mobile 90 degrees to the left or right to go from Upright Mode to Portrait Mode. ActiveTrack is disabled when using Portrait Mode.

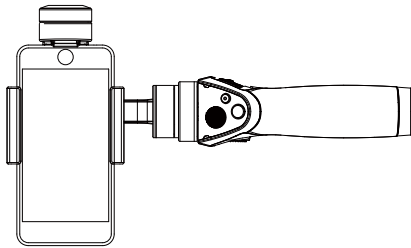

DJI GO App

Watch a live HD video feed on your mobile screen through the DJI GO app. The app also allows you to configure camera and gimbal settings in just a few taps.

Download

Search 'DJI GO' on the App Store or Google Play and download the app to your mobile device.

Connecting to the DJI GO App

1. Enable Bluetooth and turn off portrait orientation lock on your mobile phone to allow horizontal screen display.
2. Power on the Osmo Mobile. Do not touch the gimbal and hold the Osmo Mobile still and upright while it is starting up.



3. Launch DJI GO app. If you are using the Osmo Mobile for the first time, follow the on-screen instructions to activate it. You will need to log in to your DJI account through an Internet connection.
4. Enter Camera view. You will see what the camera captures in real time if it is connected successfully.

 There will be a tutorial on how to use your Osmo Mobile after entering the camera view.

 Recording will stop if you place or answer a call.

Key Pages

1. Equipment > Camera

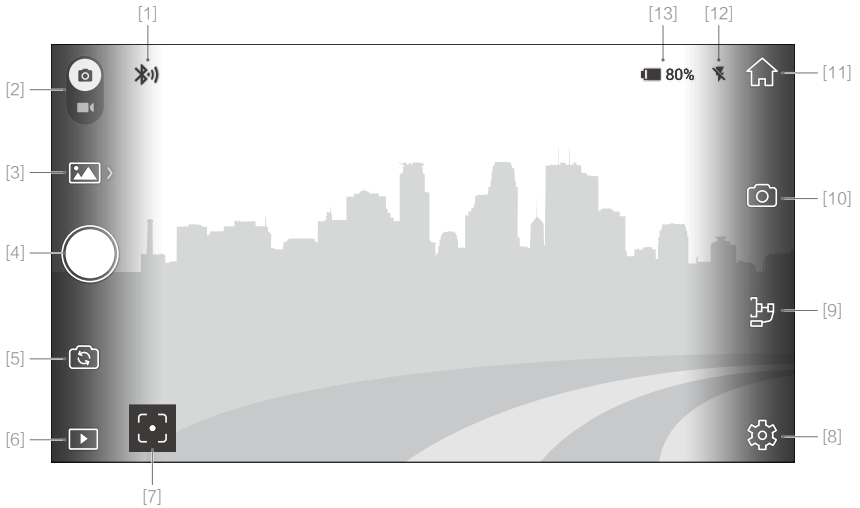

[1] Connection Status

Indicates the connecting status between DJI GO app and Osmo Mobile.

[2] 📷 / 📹 Photo/Video Toggle

Slide to switch between photo and video mode.

[3] Photo/Video Settings

📷: Photo Modes

Single shot, 2s, 5s or 10s intervals, HDR.

📹: Video Modes

- **Normal:** Normal video based on your camera settings.
- **Slow Motion:** Tap to start/stop slow motion video recording.
- **Timelapse Settings:** Select photo capture intervals and capture duration to start recording a timelapse. Tripod Mode locks the gimbal motor for greater stability. Tripod Mode is recommended when shooting a timelapse with the Osmo Mobile placed on a stable surface. If you are holding the Osmo Mobile, disable Tripod Mode to allow the gimbal to allow it to stabilize.
- **Motion Timelapse:** Use up to 5 camera positions to create a moving timelapse.

[4] ● : Shutter/Record Button

Shoots photos in Photo Mode and record video in Video Mode.

[5] 📷 : Front/Rear Camera Switch

Tap to switch between your phone's front and rear camera.

[6] ▶ : Playback

Tap to view photos and videos.

[7]  : Metering Mode/  : ActiveTrack

Tap to switch between Metering Mode and ActiveTrack.

Metering Mode: Tap on your screen for auto focus and manual exposure adjustment.

ActiveTrack: Mark an object on your screen to track it as it moves. Tap the Record button to start recording. To adjust framing of the subject being tracked, use the Joystick.

 Recording will stop if you place or answer a call.

[8]  : Settings

Camera

Adjust video resolution settings (phone dependent), and reset camera settings here.

Gimbal

• Horizontal Calibration

Adjust positive and negative values to bring the horizon to level if it is skewed.

• Auto Calibration

Reduces drift caused by nearby magnetic interference or human error. Do not touch the gimbal and hold the Osmo Mobile still and upright during calibration.

• Joystick Control Direction

Tilt and pan axis can be controlled simultaneously by setting the Joystick control direction to Free.

• Invert Joystick Left/Right Operation

Inverts left and right joystick directions, so that pushing right turns the phone left and vice versa.

• Invert Joystick Up/Down Operation

Invert up and down joystick directions, so that pushing the joystick up tilts the phone down.

General

Displays the firmware version, Intelligent Battery information and device name.

Livestream

Livestream to YouTube Live. Currently only available on iOS.

[9]  : Gimbal Preferences

Scene Mode

SmoothTrack speed varies depending on the Scene Mode. In Sport Mode, it moves faster, while in Walk Mode it is slower.

Tilt Axis Lock

Locks the tilt axis at the current angle when enabled.

[10]  : Camera Preference

Select the video resolution, flash status and enable on-screen composition grids. Enable Manual Adjustment for ISO, Shutter Speed and White Balance control. Currently available on iOS only.

[11]  : Home

Tap to navigate to the home screen.

[12] Flash Status

Displays the current status of the Flash.

[13] Battery Level

Displays the current battery level.

Zoom

Put two fingers on the screen and open to zoom in, close to zoom out. This function is available in the DJI GO app Metering Mode and when using your phone's rear camera only. Currently available on iOS only.

2. Editor

View, edit and share your masterpieces all in one place. The Editor has a range of simple but powerful tools that let you edit your videos and photos before sharing them online, minutes after they are captured.

Once you login or register your DJI account, you will be able to conveniently upload and share your creations. The saved photos and videos can be uploaded to Skypixel (www.skypixel.com) and shared on social networks such as Facebook, Twitter, WeChat, Moments and Sina Weibo.

Video

All of your recorded video footage will appear in 'Original Footage'. You can trim footage and save it to 'Create Movie'. Then, select multiple clips to create a movie quickly with the built-in editing tools and templates.

Photos

Edit your photos by adjusting the parameters, editing the photo size, adding watermarks and applying filters.

3. Skypixel

View and share the photos and videos here.

4. Me

If you already have a DJI account, you will be able to participate in forum discussions, and visit DJI online store here.

Upgrading the Firmware

Ensure that the battery has at least 50% power. It will take approximately 10 minutes to complete the upgrade. The camera status indicator will become solid green when the firmware upgrade is successful.

How to Upgrade

Connect the Osmo Mobile to your mobile device and then launch the DJI GO app. You will be reminded if a new firmware upgrade is available. To start upgrading, connect your mobile device to the internet and follow the on-screen instructions.

Do not exit the DJI GO app during the upgrade process. Pay attention to on-screen pop-ups. You should reattempt the upgrade if the upgrade is unsuccessful.

Specifications

Handle	
Dimensions	2.4×1.9×6.4 inch (61.8×48.2×161.5 mm)
Weight (battery included)	201 g
Gimbal	
Name	Zenmuse M1
Model	ZM01
Dimensions	4.92×4.29×3.57 inch (Folded) (125.06×109.15×90.98 mm)
Weight	300 g
Consumption	2.5 W
Angular Vibration Range	±0.03°
Controllable Range	Pan: ±150° ; Roll: ±25° ; Tilt: -125° to +35°
Mechanical Range	Pan: ±165° ; Roll: -50° to +90° ; Tilt: -140° to +50°
Max Controllable Speed	120°/s
Mobile Phone Width Range	2.31-3.34 inch (58.6-84.8 mm)
Wireless	
Model	Bluetooth Low Energy 4.0
Intelligent Battery	
Model	HB01-522365
Type	LiPo
Capacity	980 mAh
Energy	10.8 Wh
Voltage	11.1 V
Charging Temperature	5° to 40° C (41° to 104° F)
Operating Temperature	0° to 40° C (32° to 104° F)

This content is subject to change.

**Download the latest version from
www.dji.com/product/osmo-mobile**

If you have any questions about this document, please contact DJI by sending a message to **DocSupport@dji.com**.

OSMO™ is a trademark of DJI.
Copyright © 2016 DJI All Rights Reserved.

